

18Gbps 8x8 HDBaseT (150M) Matrix



User Manual

VER 1.0

Thank you for purchasing this product

For optimum performance and safety, please read these instructions carefully before connecting, operating or adjusting this product. Please keep this manual for future reference.

Surge protection device recommended

This product contains sensitive electrical components that may be damaged by electrical spikes, surges, electric shock, lightning strikes, etc. Use of surge protection systems is highly recommended in order to protect and extend the life of your equipment.

Table of Contents

1. Introduction.....	1
2. Features.....	1
3. Package Contents.....	2
4. Specifications.....	2
5. Operation Controls and Functions.....	4
5.1. Matrix Panel.....	4
5.2. HDBaseT Receiver Panel.....	6
6. IR Remote.....	7
7. IR Control System.....	8
8. IR Cable Pin Assignment.....	10
9. EDID Management.....	10
10. Web GUI User Guide.....	12
11. RS-232 Control Command.....	19
12. Application Example.....	25

1. Introduction

The 18Gbps 8x8 HDBaseT(150M) Matrix can connect 8 HDMI sources to 16 displays. It features 8 HDMI outputs and each HDMI output is mirrored to provide a CAT-Cable output which runs simultaneously. HDBaseT output can extend video transmission distance up to 492ft / 150m via a single Cat 5e/6/7 cable and the resolution is up to 4K2K@60Hz 4:4:4. Audio de-embedded to analog and coaxial audio is supported. Each HDMI output supports 4K2K to 1080P downscaler independently.

The product supports IR matrix. The IR signal is one-to-one control at the Matrix end, but the IR signal follows HDMI video channel at the HDBaseT Receiver end.

The product provides an intuitive set of front panel with OLED screen and supports control via front panel buttons, IR remote, RS-232, LAN, and Web GUI.

2. Features

- ☆ HDMI 2.0b, HDCP 2.2 and HDCP 1.x compliant
- ☆ Video resolution up to 4K2K@60Hz (YUV 4:4:4) on all HDMI & HDBaseT ports
- ☆ 8 HDMI inputs, 8 HDMI & HDBaseT mirrored outputs
- ☆ HDMI ports transmit 18Gbps lossless uncompressed video bandwidth
- ☆ Support 18Gbps lossless compressed HDBaseT signal transmission
- ☆ Support 4K->1080P Down Scaler for each output port
- ☆ HDR, HDR10, HDR10+, Dolby Vision, HLG are supported
- ☆ HDBaseT output can extend video transmission distance up to 492ft / 150m for 1080P or 394ft / 120m for 4K2K via a single Cat 5e/6/7 cable
- ☆ HDMI audio pass-through up to 7.1CH HD audio (LPCM, Dolby TrueHD and DTS-HD Master Audio)
- ☆ Support IR matrix
- ☆ Audio de-embedded is supported via analog and coax ports
- ☆ Advanced EDID management and CEC control are supported
- ☆ 24V POC on all HDBaseT ports
- ☆ 1U rack mounted design with front panel OLED display
- ☆ Control via front panel buttons, IR remote, RS-232, LAN and Web GUI

3. Package Contents

- ① 1 x 18Gbps 8x8 HDBaseT(150M) Matrix
- ② 8 x HDBaseT Receiver
- ③ 1 x Matrix IR Remote
- ④ 1 x 100~240V AC 50/60Hz Power cable
- ⑤ 1 x RS-232 serial cable (1.5 meters, male to female head)
- ⑥ 8 x 3-pin Phoenix Connector & 8 x 5-pin Phoenix Connector
- ⑦ 9 x IR Blaster cable (1.5 meters)
- ⑧ 9 x IR Receiver cable (1.5 meters)
- ⑨ 18 x Mounting Ear (Matrix and Receiver)
- ⑩ 1x User Manual

4. Specifications

Technical	
HDMI Compliance	HDMI 2.0b
HDCP Compliance	HDCP 2.2 and HDCP 1.x
Video Bandwidth	18Gbps
Video Resolution	Up to 4K2K@50/60Hz (4:4:4)
Color Space	RGB 4:4:4, YCbCr 4:4:4/4:2:2/4:2:0
Color Depth	8-bit, 10-bit, 12-bit (1080p@60Hz) 8-bit (4K2K@60Hz YUV4:4:4) 8-bit, 10-bit, 12-bit (4K2K@60Hz YCbCr 4:2:2/4:2:0)
HDR	HDR10, HDR10+, Dolby Vision, HLG
HDMI Audio Formats	LPCM 2.0/2.1/5.1/6.1/7.1, Dolby Digital, Dolby TrueHD, Dolby Digital Plus(DD+), DTS-ES, DTS HD Master, DTS HD-HRA, DTS-X
Coax Audio Formats	PCM 2.0, Dolby Digital / Plus, DTS 2.0/5.1
Analog Balanced Audio Formats	PCM2.0CH
Vmax	2Vrms
SNR	>90dB
THD+N Ratio	<0.1% (V_max) 0.001%~0.01% (V_best)
Crosstalk	>80dB
Frequency Response	20Hz~20kHz ±0.5dB
ESD Protection	Human-body Model: ±8kV (Air-gap discharge) , ±4kV (Contact discharge)

Connection			
Matrix	Inputs: 8 x HDMI Type A [19-pin female] Outputs: 8 x HDMI Type A [19-pin female] 8 x HDBaseT port [RJ45] 8 x Coaxial audio [3.5mm Stereo Mini-jack] 8 x balanced analog audio [5-pin Phoenix connector] Controls: 9 x IR IN [3.5mm Stereo Mini-jack] 9 x IR OUT [3.5mm Stereo Mini-jack] 1 x TCP/IP [RJ45] 1 x RS-232 [D-Sub 9]		
HDBaseT Receiver	Input: 1 x HDBT IN [RJ45, 8-pin female] Outputs: 1 x HDMI Type A [19-pin female] 1 x AUDIO OUT [3.5mm Stereo Mini-jack] Controls: 1 x IR IN [3.5mm Stereo Mini-jack] 1 x IR OUT [3.5mm Stereo Mini-jack] 1 x RS-232 [3-pin Phoenix connector] 1 x SERVICE [Mini-USB, Update port]		
Mechanical			
Housing	Metal Enclosure		
Color	Black		
Dimensions	Matrix: 440mm (W) x 374mm (D) x 88.6mm (H) Receiver: 140mm (W) x 65mm (W) x 18mm (W)		
Weight	Matrix: 6.54Kg, Receiver: 155g		
Power Supply	AC 100 - 240V 50/60Hz		
Power Consumption	125W (Max)		
Operating Temperature	0°C ~ 40°C / 32°F ~ 104°F		
Storage Temperature	-20°C ~ 60°C / -4°F ~ 140°F		
Relative Humidity	20~90% RH (non-condensing)		
Resolution / Distance	4K60 - Feet / Meters		
CAT5e/6/7	492ft / 150M		
Resolution / Cable length	4K60 - Feet / Meters	4K30 - Feet / Meters	1080P60 - Feet / Meters
HDMI IN / OUT	16ft / 5M	32ft / 10M	50ft / 15M
The use of "Premium High Speed HDMI" cable is highly recommended.			

5. Operation Controls and Functions

5.1 Matrix Panel

Front Panel

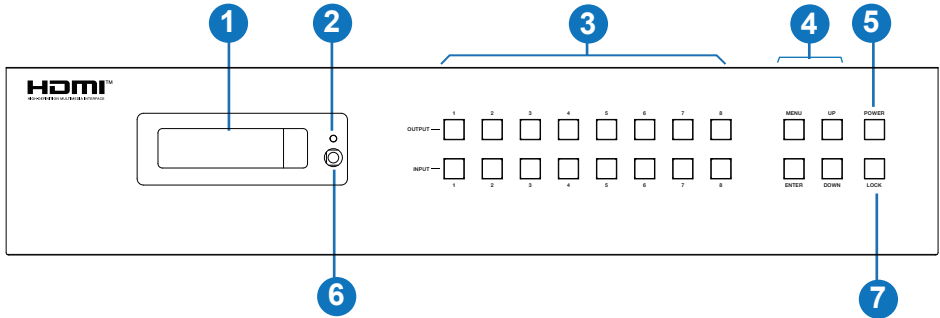

NO.	Name	Function Description
1	OLED screen	Display matrix switching status, input / output port, EDID, Baud rate, IP Address.
2	Power LED	The LED will illuminate in green when the product is working normally, and red when the product is on standby.
3	OUTPUT / INPUT buttons	You need to press an output button (1~8) firstly and then press an input button (1~8) to select the corresponding input source for the output port.
4	MENU / ENTER / UP /DOWN	<p>①EDID setting: On the initial OLED display screen, press “MENU” button to enter “Select EDID” interface, press “UP/DOWN” button to select the required EDID, and press the “ENTER” button to enter “Copy to Input:” interface. Then press “UP/DOWN” button to select the input port you need to set, and press “ENTER” button again to confirm.</p> <p>②Baud rate setting: On the initial OLED display screen, press “MENU” button twice to enter “SELECT BAUD” interface, and press “UP/DOWN” button to select the required Baud rate, finally press the “ENTER” button to confirm the setting.</p> <p>③IP Address Check: On the initial OLED display screen, press “MENU” button three times to enter the IP interface and check the current IP address, then press “UP/DOWN” button to switch DHCP ON/OFF, finally press the “ENTER” button to confirm the setting.</p> <p>Pressing the “MENU” button again will return to the initial OLED display status.</p>
5	POWER button	Press and hold the POWER button for 3 seconds to enter the standby mode, then press the button again to wake up the device.
6	IR Window	IR receiver window, it only receives the IR remote signal from this product.
7	LOCK button	Press the LOCK button to lock front panel buttons (Except the power button); Press the button again to unlock.

Rear Panel

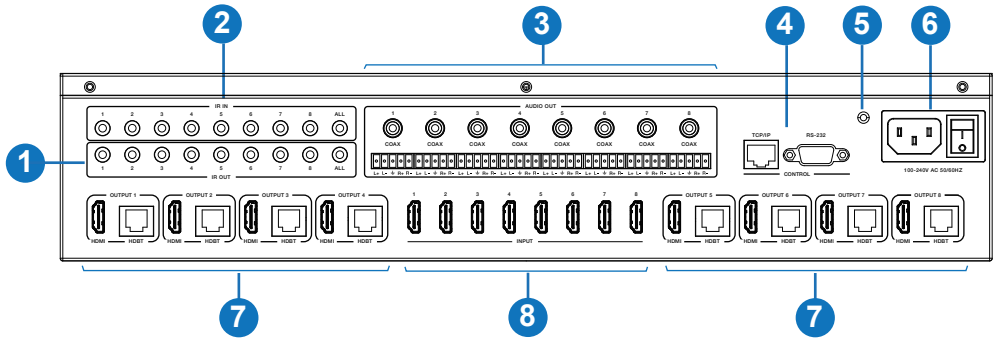

No.	Name	Function Description
1	IR OUT (1-8/ ALL) ports	Connect to IR blaster cable, the IR emit signal is from the "IR IN" port of the HDBaseT Receiver.
2	IR IN (1-8/ALL) ports	Connect to IR receiver cable, the IR receive signal will emit to the "IR OUT" port of the HDBaseT Receiver.
3	AUDIO OUT (1-8) ports	8 groups of coaxial and balanced analog audio mirrored output ports. AUDIO OUT (1-8) follows the video output of OUTPUT (1-8) ports.
4	CONTROL ports	TCP/IP: The link port for TCP/IP control. Connect to an active Ethernet link with an RJ45 cable. RS-232: Command control port. Connect to a PC or control system with a D-Sub 9-pin cable to control the Matrix.
5	GND	Connect the housing to the ground.
6	POWER input	Power port: Connect to 100~240V AC 50/60Hz power cable. Power switch: Press the switch to turn on/off the power.
7	OUTPUT (1-8) ports	HDMI output ports, connect to HDMI display device such as TV or monitor with an HDMI cable. HDBT mirrored output ports, connect to HDBaseT Receiver via CAT cable.
8	INPUT (1-8) ports	HDMI input ports, connect to HDMI source device such as DVD or PS4 with an HDMI cable.

Data Signal Indicator Lamp

- Illuminating: HDMI signal with HDCP.
- Flashing: HDMI signal without HDCP.
- Dark: No HDMI signal.



Video (OUT)

Connection Signal Indicator Lamp

- Illuminating: Matrix and HDBaseT Receiver are in good connection status.
- Flashing: Matrix and HDBaseT Receiver are in poor connection status.
- Dark: Matrix and HDBaseT Receiver are not connected.

5.2 HDBaseT Receiver Panel

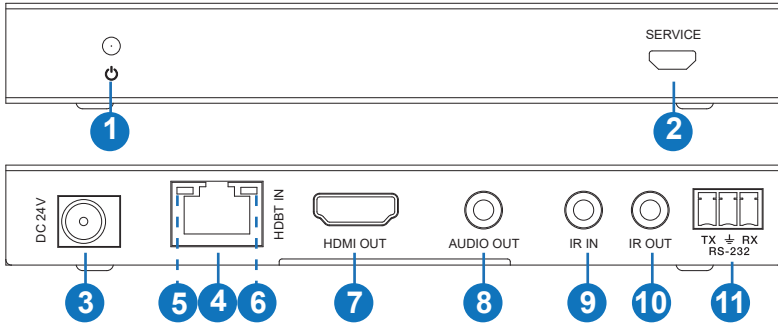

No.	Name	Function Description
1	Power LED	Red LED will be on when the receiver is powered on.
2	SERVICE port	Firmware update port.
3	DC 24V	DC 24V/1A power supply input port. Note: The Matrix supports POC function, it means that either transmitter or receiver is powered on by 24V/1A power adapter, the other one doesn't need power supply.
4	HDBT IN	RJ45 connector for connecting the HDBT OUTPUT port of Matrix with a CAT cable.
5	Connection Signal Indicator lamp	<ul style="list-style-type: none"> ▪ Illuminating: Matrix and Receiver are in good connection status. ▪ Flashing: Matrix and Receiver are in poor connection status. ▪ Dark: Matrix and Receiver are not connected.
6	Data Signal Indicator	<ul style="list-style-type: none"> ▪ Illuminating: HDMI signal with HDCP. ▪ Flashing: HDMI signal without HDCP. ▪ Dark: No HDMI signal.
7	HDMI OUT	HDMI output port, connect to HDMI display device such as TV or monitor with HDMI cable.
8	AUDIO OUT	Analog audio output port. The audio is extracted from HDMI signal.
9	IR IN	Connect to IR receiver cable, the IR receive signal will emit to the "IR OUT" port of the Matrix.
10	IR OUT	Connect to IR blaster cable, the IR emit signal is from the "IR IN" port of the Matrix.
11	RS-232	Connect to a PC or control system with a 3-pin phoenix connector cable to transmit command between the Matrix and HDBaseT Receiver.

6. IR Remote

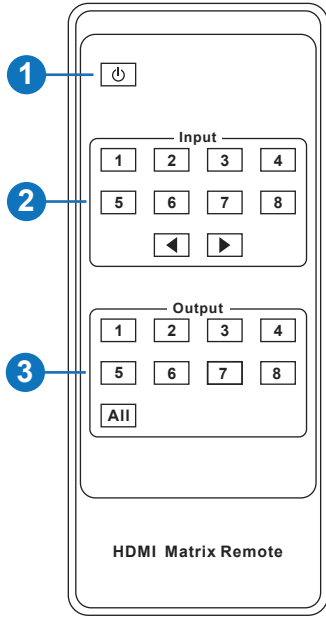

- ① **Power on or Standby:** Power on the Matrix or set it to standby mode.
- ② **Input 1/2/3/4/5/6/7/8:** Select input source button.
◀ ▶ : Select the last or next input source button.
- ③ **Output 1/2/3/4/5/6/7/8 button:** Select output source button.

All: Select all output source simultaneously. For example, when you press the “All” button and then press input “1” button, at this time the input “1” source will output to all display devices.

Operation instruction: You need to press the output button firstly and then press input button to select the corresponding input source. For example,
Press Output-X
(X means output button from 1 to 8 , including “All” button)
Then press Input-Y
(Y means input button from 1 to 8)

7. IR Control System

The product is not only a matrix switch but also an extender. It supports bi-directional IR control. When Matrix is connected to HDBaseT Receiver through Cat 5e/6/7 cable, you can control remote display device (HDBaseT) or input source device (Matrix) through IR signal transmission. But you must note that the IR signal transmission method is different from the method from Matrix (local) to HDBaseT Receiver (remote) and from HDBaseT Receiver (remote) to Matrix (local).

At the Matrix end (Local end): the IR signal is one-to-one transmission. For example, the IR IN 1 port signal of the Matrix will emit to IR OUT port of the HDBaseT Receiver 1, and the IR IN 3 port signal of the Matrix will emit to IR OUT port of the HDBaseT Receiver 3. It doesn't follow the video switch to change. IR IN ALL port signal of the Matrix will emit to all IR OUT ports of HDBaseT receivers simultaneously. Please see the following connection diagram.

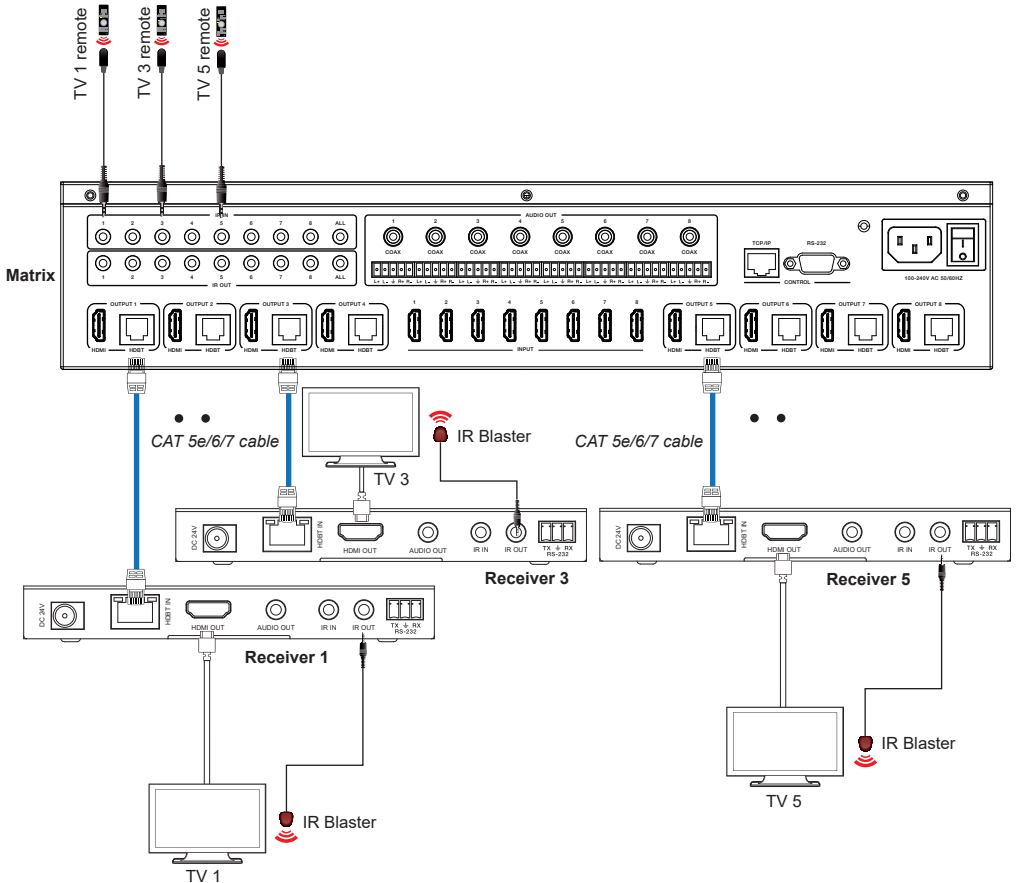

Figure 1: IR connection diagram (Matrix end)

At HDBaseT receiver (Remote end): IR signal follows video switch to change. For example, the HDMI output signal on the HDBaseT Receiver 1 is from the HDMI INPUT 2 port, so IR input signal of the HDBaseT Receiver 1 will emit to IR OUT 2 port of the Matrix. The HDMI output signal on the HDBaseT Receiver 5 is from the HDMI INPUT 4 port. Then, IR input signal of the HDBaseT Receiver 5 will emit to IR OUT 4 port of the Matrix etc. Any of HDBaseT Receiver's IR IN signal can output from IR OUT ALL port of the Matrix and the IR OUT ALL signal of the Matrix depends on your IR remote of source device. Please see the following connection diagram.

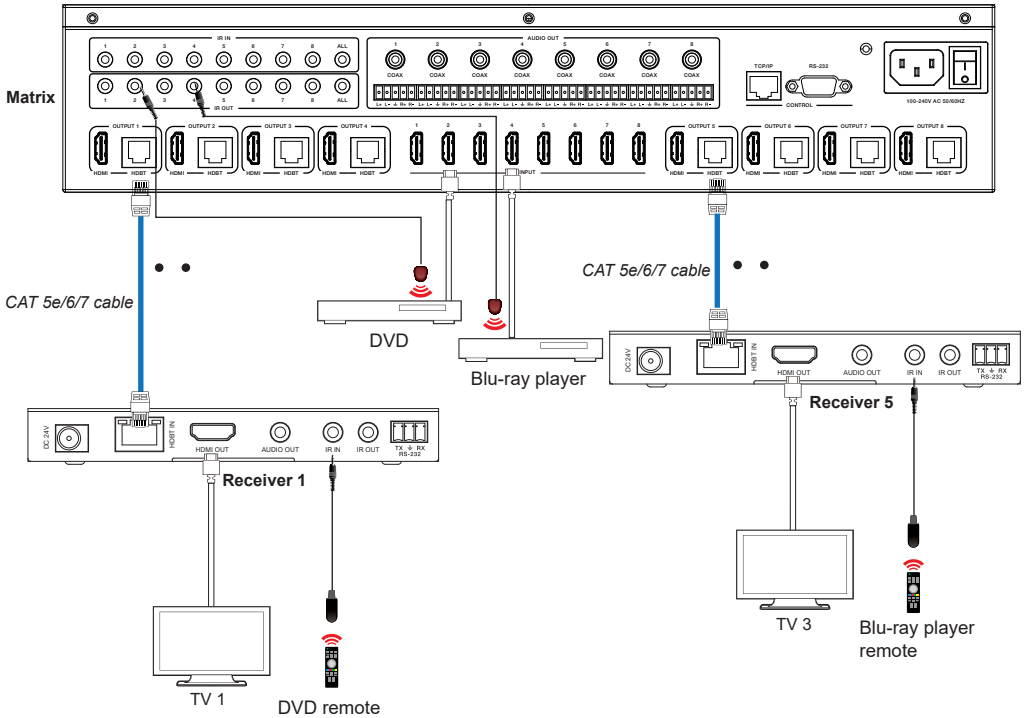
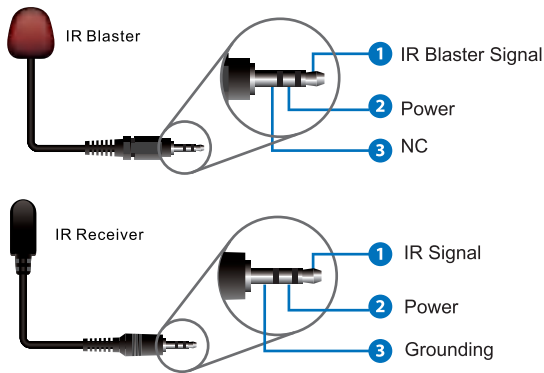

Figure 2: IR connection diagram (HDBaseT Receiver end)

8. IR Cable Pin Assignment



9. EDID Management

This Matrix has 21 factory defined EDID settings, 2 user-defined EDID modes and 16 copy EDID modes. You can select defined EDID mode or copy EDID mode to input port through on-panel button, RS-232 control or Web GUI.

On-panel button operation: On the initial OLED display screen, press “MENU” button to enter the EDID setting interface, press “UP/DOWN” button to select the required EDID, and press the “ENTER” button to enter “Copy to Input:” interface. Then press “UP/DOWN” button to select the input port you need to set, and press “ENTER” button again to confirm this operation.

RS-232 control operation: Connect the Matrix to PC with a serial cable, then open a Serial Command tool on PC to send ASCII command “s edid in x from z!” to set EDID. For details, please refer to “EDID Setting” in the ASCII command list of “11. RS-232 Control Command”.

Web GUI Operation: Please check the EDID management in the “Input page” of “10. Web GUI User Guide”.

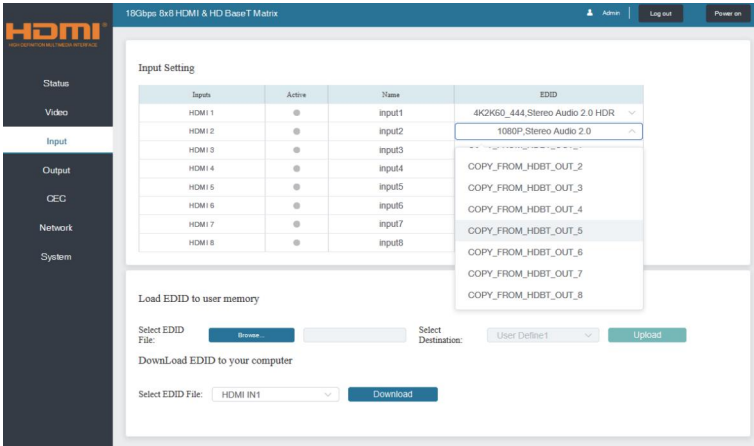

The defined EDID setting list of the product is shown as below:

EDID Mode	EDID Description
1	1080p, Stereo Audio 2.0
2	1080p, Dolby/DTS 5.1
3	1080p, HD Audio 7.1
4	1080i, Stereo Audio 2.0
5	1080i, Dolby/DTS 5.1
6	1080i, HD Audio 7.1
7	3D, Stereo Audio 2.0
8	3D, Dolby/DTS 5.1
9	3D, HD Audio 7.1
10	4K2K30_444, Stereo Audio 2.0
11	4K2K30_444, Dolby/DTS 5.1
12	4K2K30_444, HD Audio 7.1
13	4K2K60_420, Stereo Audio 2.0
14	4K2K60_420, Dolby/DTS 5.1
15	4K2K60_420, HD Audio 7.1
16	4K2K60_444, Stereo Audio 2.0
17	4K2K60_444, Dolby/DTS 5.1
18	4K2K60_444, HD Audio 7.1
19	4K2K60, Stereo Audio 2.0 HDR
20	4K2K60, Dolby/DTS 5.1 HDR
21	4K2K60, HD Audio 7.1HDR
22	User define1
23	User define2
24~31	Copy from HDMI OUTPUT 1~8
32~39	Copy from HDBT OUTPUT 1~8

10. Web GUI User Guide

The Matrix can be controlled by Web GUI. The operation method is shown as below:

Step 1: Get the current IP Address.

The default IP address is 192.168.1.100. You can get the current Matrix IP address in two ways:

The first way: You can get the IP address via panel buttons. On the initial OLED display, press “MENU” button three times to enter the IP interface and check the current IP address.

The second way: You can get the IP address via RS-232 control. Send the ASCII command “r ipconfig!” through a Serial Command tool, then you’ll get the feedback information as shown below:

```
[11:00:55.617]发->◇r ipconfig!  
□  
[11:00:55.710]收←◆IP Mode: DHCP  
IP:192.168.61.103  
Subnet Mask:255.255.255.0  
Gateway:192.168.61.1  
Mac address:6c-df-fb-03-d5-e0  
TCP/IP port=65534  
telnet port=998
```

IP:192.168.61.103 in the above figure is the current Matrix IP address (this IP address is variable, depending on what the specific machine returns).

For the details of RS-232 control, please refer to “11. RS-232 Control Command”.

Step 2: Connect the TCP/IP port of the Matrix to a PC with an UTP cable (as shown in the following figure), and set the IP address of the PC to be in the same network segment with the Matrix.

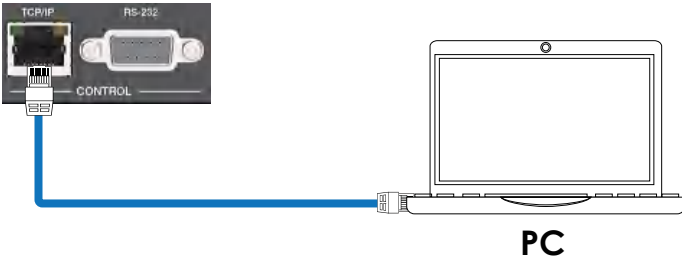

Step 3: Input the current IP address of Matrix into your browser on the PC to enter Web GUI page.



After entering the Web GUI page, there will be a Login page, as shown below:



Select the Username from the list and enter the password. The default passwords are:

Username	User	Admin
Password	user	admin

After entering the password, click the “LOGIN” button and the following Status page will appear.

■ Status Page

The Status page provides basic information about the product model, installed firmware version and the network settings of the device.

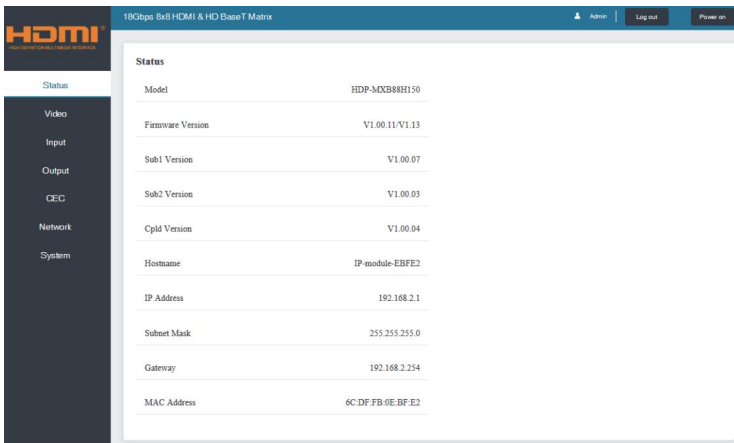

■ Video Page

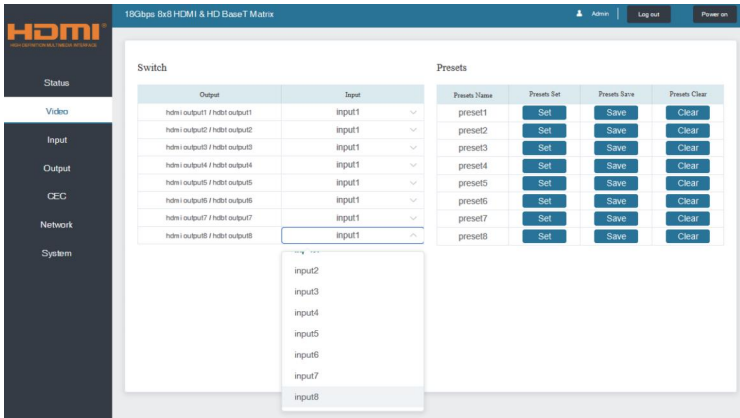

You can do the following operations on the Video page:

- ① **Output:** The current device's OUTPUT port. You can select signal source for it.
- ② **Input:** You can click the drop-down menu to select signal source for the corresponding OUTPUT port .
- ③ **Presets Name:** You can name the current scene with maximum length of 12 characters (Chinese name is unsupported).
- ④ **Presets Set:** You can restore the settings of the last saved audio-video matrix switching relationship.
- ⑤ **Presets Save:** You can save audio-video matrix switching relationship.
- ⑥ **Presets Clear:** You can clear the saved audio-video matrix switching relationship.

■ Input Page

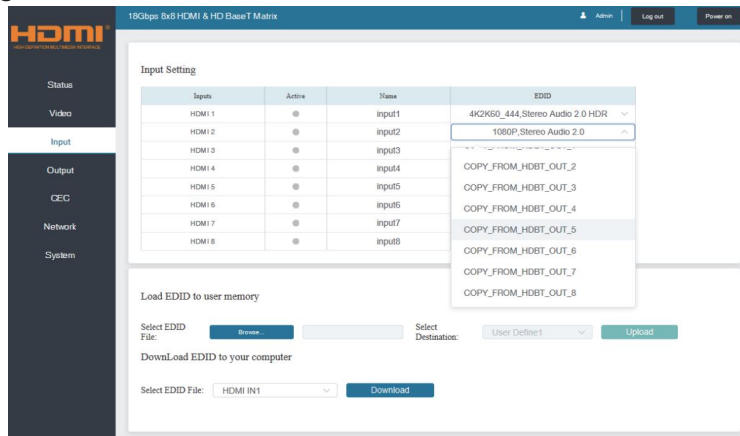

You can do the following operations on the Input page:

- ① **Inputs:** Input channel of the device.
- ② **Active:** It indicates whether the channel is connected to a signal source.
- ③ **Name:** The input channel's name. You can modify it by entering the corresponding name (max length: 12 characters) in the input box (Chinese name is unsupported).
- ④ **EDID:** You can set the current channel's EDID. The specific operation is as follows:

Set EDID for the User

Click the “Browse” button, then select the bin file. If you select the wrong EDID file, there will be a prompt, as shown in the following figure:

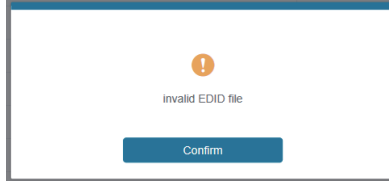

Make sure to select the correct file, then you can check the name of the selected file. Select “User 1” or “User 2”, then click “Upload”. After successful setting, it will prompt as follows:

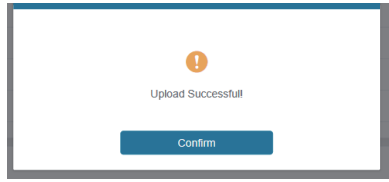

Download the EDID File for the Corresponding Input Channel

Click the drop-down box of “Select EDID File” to select the corresponding input channel. Then click “Download” to download the corresponding EDID file.

■ Output Page

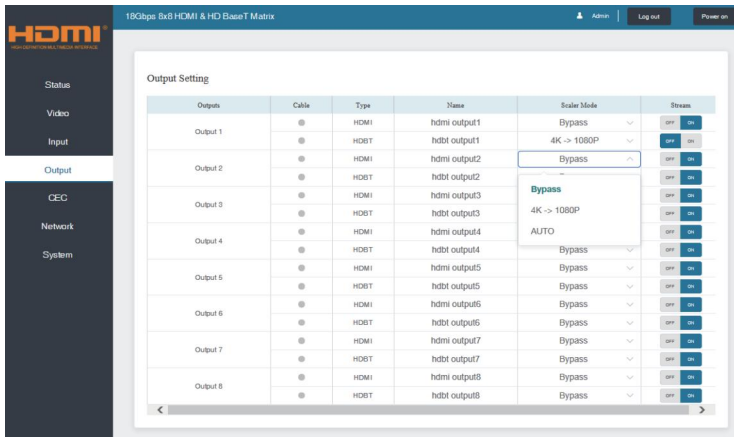

The screenshot shows the "Output Setting" page of an HDMI Matrix. The page has a dark blue header with the "HDMI" logo and navigation links for "Admin", "Log out", and "Power on". A left sidebar contains menu items: "Status", "Video", "Input", "Output", "CEC", "Network", and "System". The main content area displays a table with the following columns: "Output", "Cable", "Type", "Name", "Scaler Mode", and "Stream".

Output	Cable	Type	Name	Scaler Mode	Stream
Output 1	<input type="radio"/>	HDMI	hdmi output1	Bypass	<input type="checkbox"/>
	<input type="radio"/>	HDBT	hdbt output1	4K -> 1080P	<input type="checkbox"/>
Output 2	<input type="radio"/>	HDMI	hdmi output2	Bypass	<input type="checkbox"/>
	<input type="radio"/>	HDBT	hdbt output2	Bypass	<input type="checkbox"/>
Output 3	<input type="radio"/>	HDMI	hdmi output3	Bypass	<input type="checkbox"/>
	<input type="radio"/>	HDBT	hdbt output3	4K -> 1080P	<input type="checkbox"/>
Output 4	<input type="radio"/>	HDMI	hdmi output4	AUTO	<input type="checkbox"/>
	<input type="radio"/>	HDBT	hdbt output4	Bypass	<input type="checkbox"/>
Output 5	<input type="radio"/>	HDMI	hdmi output5	Bypass	<input type="checkbox"/>
	<input type="radio"/>	HDBT	hdbt output5	Bypass	<input type="checkbox"/>
Output 6	<input type="radio"/>	HDMI	hdmi output6	Bypass	<input type="checkbox"/>
	<input type="radio"/>	HDBT	hdbt output6	Bypass	<input type="checkbox"/>
Output 7	<input type="radio"/>	HDMI	hdmi output7	Bypass	<input type="checkbox"/>
	<input type="radio"/>	HDBT	hdbt output7	Bypass	<input type="checkbox"/>
Output 8	<input type="radio"/>	HDMI	hdmi output8	Bypass	<input type="checkbox"/>
	<input type="radio"/>	HDBT	hdbt output8	Bypass	<input type="checkbox"/>

You can do the following operations on the Output page:

- ① **Outputs:** Output channel of the device.
- ② **Name:** The current output channel's name. You can modify it by entering the corresponding name (max length: 12 characters) in the input box (Chinese name is unsupported).
- ③ **Type:** The current output channel's type (HDMI or HDBT).
- ④ **Cable:** It indicates the connection status of output ports. When the output port is connected to the display, it shows green, otherwise, it shows gray.
- ⑤ **Scaler Mode:** Set the current output resolution mode.
- ⑥ **Stream:** Turn on/off the output stream.

■ CEC Page



You can perform CEC management on this page:

- ① **Input Control:** You can control the operation of each input source by pressing the icons on the page. (You can control multiple inputs simultaneously.)
- ② **Output Control:** You can control the operation of each display, such as power on/off, volume +/-, active source switching. (You can control multiple outputs simultaneously.)

■ Network Page

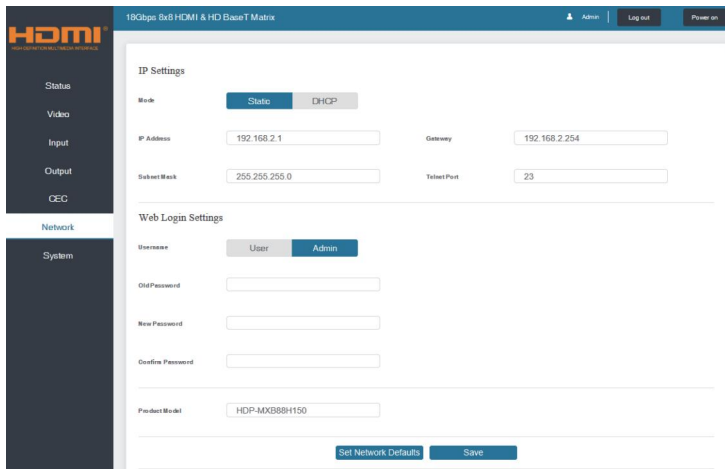

Set the Default Network

Click "Set Network Defaults" button, there will be a prompt, as shown in the following figure:

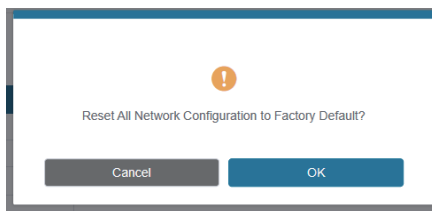

Click “OK” to search the IP Address again, as shown in the following figure:

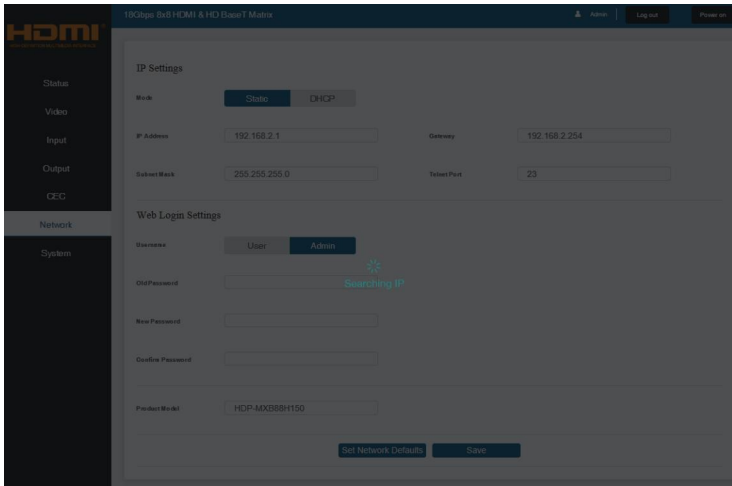

After searching is completed, it will switch to the login page, the default network setting is completed.

Modify User Password

Click the “User” button, enter the correct Old Password, New Password, and Confirm Password, then click “Save”. After successful modification, there will be a prompt, as shown in the following figure:

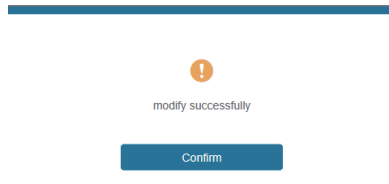

Note: Input rules for changing passwords:

- (1) The password can't be empty.
- (2) New Password can't be the same as Old Password.
- (3) New Password and Confirm Password must be the same.

Modify Network Setting

Modify the Mode/IP Address/Gateway/Subnet Mask/Telnet Port as required, click “Save” to save the settings, then it will come into effect.

After modification, if the Mode is “Static”, it will switch to the corresponding IP Address; if the Mode is “DHCP”, it will automatically search and switch to the IP Address assigned by the router.

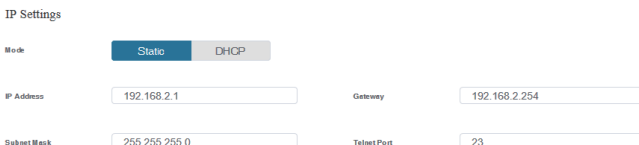

■ System Page

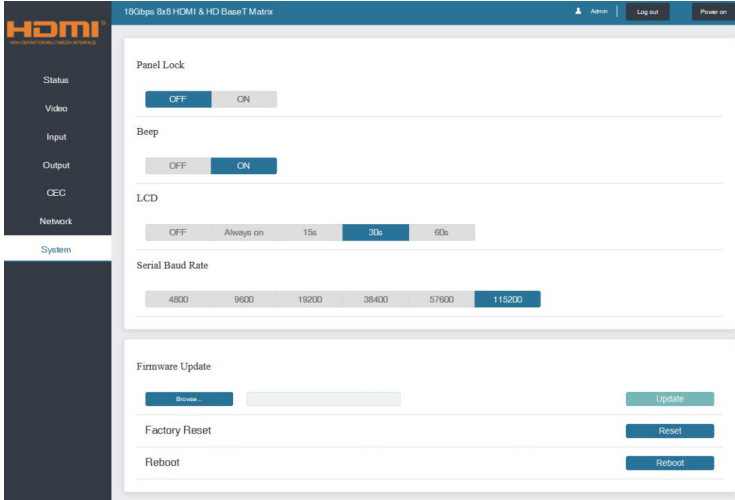

- ① **Panel Lock:** Click to lock/unlock panel buttons. “On” indicates that panel buttons are unavailable; “Off” indicates panel buttons are available.
- ② **Beep:** Click to turn on/off the beep.
- ③ **LCD:** You can turn on/off the LCD, and set the turn-on time (15s/30s/60s).
- ④ **Serial Baud Rate:** Click the value to set the Serial Baud Rate.
- ⑤ **Firmware Update:** Click “Browse” to select the update file, then click “Update” to complete firmware update.
- ⑥ **Factory Reset:** You can reset the machine to factory defaults by clicking “Reset”.
- ⑦ **Reboot:** You can reboot the machine by clicking “Reboot”.

Note: After reset/reboot, it will switch to the login page.

11. RS-232 Control Command

The product also supports RS-232 control. You need a serial cable with RS-232 male head and DB9 transfer USB male head. The RS-232 head of the serial cable is connected to the RS-232 control port with DB 9 at the rear of the Matrix, and the USB head of the serial cable is connected to a PC. The connection method is as follows:

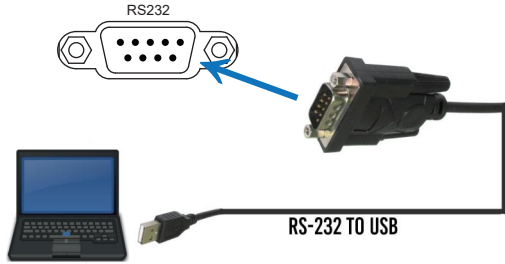

Then, open a Serial Command tool on PC to send ASCII command to control the Matrix.

The ASCII command list about the product is shown as below.

ASCII Command				
Serial port protocol. Baud rate: 115200, Data bits: 8bit, Stop bits:1, Check bit: 0				
x - Parameter 1 y - Parameter 2 ! - Delimiter				
Command Code	Function Description	Example	Feedback	Default Setting
Power				
s power z!	Power on/off the device,z=0~1 (z=0 power off, z=1 power on)	s power 1!	Power on System Initializing... Initialization Finished! FW version x.xx.xx	power on
r power!	Get current power state	r power!	power on/power off	
s reboot!	Reboot the device	s reboot!	Reboot... System Initializing... Initialization Finished! FW version x.xx.xx	
System Setup				
help!	List all commands	help!		
r type!	Get device model	r type!	HDP-MXB88H150	
r status!	Get device current status	r status!	Get the unit all status: power, beep, lock, in/ out connection, video/ audio crosspoint, edid, scaler,hdcv, network status	
r fw version!	Get Firmware version	r fw version!	MCU BOOT:Vx.xx.xx MCU APP :Vx.xx.xx SUB1 APP :Vx.xx.xx SUB2 APP :Vx.xx.xx CPLD APP :Vx.xx.xx WEB GUI :Vx.xx	

Command Code	Function Description	Example	Feedback	Default Setting
r link in x!	Get the connection status of the x input port, x=0~8(0=all)	r link in 1!	hdmi input 1: connect	
r link out y!	Get the connection status of the y output port, y=0~8(0=all)	r link out 1!	hdmi output 1: connect hdbt output 1: connect	
s reset!	Reset to factory defaults	s reset!	Reset to factory defaults System Initializing... Initialization Finished! FW version x.xx.xx	
s beep z!	Enable/Disable buzzer function, z=0~1(z=0 beep off, z=1 beep on)	s beep 1!	beep on beep off	beep on
r beep!	Get buzzer state	r beep!	beep on / beep off	
s lock z!	Lock/Unlock front panel button, z=0~1 (z=0 lock off,z=1 lock on)	s lock 1!	panel button lock on panel button lock off	panel button lock off
r lock!	Get panel button lock state	r lock!	panel button lock on/off	
s lcd on time z!	Set LCD screen remain on time, z=0~4 (0:off, 1:always on, 2:15s, 3:30s, 4:60s)	s lcd on time 1!	lcd always on	lcd on 30 seconds
r lcd mode!	Get the backlight status of lcd screen	r lcd mode!	lcd always on	
s save preset z!	Save switch state between all output port and the input port to preset z, z=1~8	s save preset 1!	save to preset 1	
s recall preset z!	Call saved preset z scenarios, z=1~8	s recall preset 1!	recall from preset 1	
s clear preset z!	Clear stored preset z scenarios, z=1~8	s clear preset 1!	clear preset 1	
r preset z!	Get preset z information, z=1~8	r preset 1!	video/audio crosspoint	
s logo1 *****!	Set the logo name displayed on the first line of LCD screen, the max character is 16	s logo1 Matrix Switch!	logo1:Matrix Switch	
s baud rate xxx!	Set the serial port baud rate of RS02 module, z=(115200,57600,38400,19200,9600,4800)	s baud rate 115200!	Baudrate:115200	115200
r baud rate!	Get the serial port baud rate of RS02 module	r baud rate!	Baudrate:115200	
s id z!	Set the control ID of the product, z=000~999	s id 888!	id 888	0
Output Setting				
s in x av out y!	Set input x to output y, x=1~8, y=0~8(0=all)	s in 1 av out 2!	input 1 -> output 2	ptp
r av out y!	Get output y signal status y=0~8(0=all)	r av out 0!	input 1 -> output 1 input 2 -> output 2 input 8 -> output 8	
s hdmi y stream z!	Set hdmi output y stream on/off, y=0~8(0=all) z=0~1(0:disable,1:enable)	s hdmi 1 stream 1! s hdmi 0 stream 1!	enable hdmi output 1 stream disable hdmi output 1 stream enable hdmi all outputs stream disable hdmi all outputs stream	enable
r hdmi y stream!	Get hdmi output y stream status, y=0~8(0=all)	r hdmi 1 stream!	enable hdmi output 1 stream	

Command Code	Function Description	Example	Feedback	Default Setting
s hdbt y stream z!	Set hdbt output y stream on/off, y=0~8(0=all) z=0~1(0:disable,1:enable)	s hdbt 1 stream 1! s hdbt 0 stream 1!	enable hdbt output 1 stream disable hdbt output 1 stream enable hdbt all outputs stream disable hdbt all outputs stream	enable
r hdbt y stream!	Get hdbt output y stream status, y=0~8(0=all)	r hdbt 1 stream!	enable hdbt output 1 stream	
s hdmi y scaler z!	Set hdmi output y port output scaler mode, y=0~8(0=all), z=1~3(1=bypass,2=4k->1080p, 3=Auto)	s hdmi 1 scaler 1! s hdmi 0 scaler 1!	hdmi output 1 set to bypass mode hdmi all outputs set to bypass mode	hdmi all outputs set to bypass mode
r hdmi y scaler!	Get hdmi output y port output mode y=0~8(0=all)	r hdmi 1 scaler!	hdmi output 1 set to bypass mode	
s hdbt y scaler z!	Set hdbt output y port output scaler mode, y=0~8(0=all), z=1~3(1=bypass,2=4k->1080p, 3=Auto)	s hdbt 1 scaler 1! s hdbt 0 scaler 1!	hdbt output 1 set to bypass mode hdbt all outputs set to bypass mode	hdbt all outputs set to bypass mode
r hdbt y scaler !	Get hdbt output y port output mode y=0~8(0=all)	r hdbt 1 scaler !	hdbt output 1 set to bypass mode	
EDID Setting				
s edid in x from z!	Set input x EDID from default EDID z x=0~8(0=all),z=1~39 1, 1080p, Stereo Audio 2.0 2, 1080p, Dolby/DTS 5.1 3, 1080p, HD Audio 7.1 4, 1080i, Stereo Audio 2.0 5, 1080i, Dolby/DTS 5.1 6, 1080i, HD Audio 7.1 7, 3D, Stereo Audio 2.0 8, 3D, Dolby/DTS 5.1 9, 3D, HD Audio 7.1 10, 4K2K30_444, Stereo Audio 2.0 11, 4K2K30_444, Dolby/DTS 5.1 12, 4K2K30_444, HD Audio 7.1 13, 4K2K60_420, Stereo Audio 2.0 14, 4K2K60_420, Dolby/DTS 5.1 15, 4K2K60_420, HD Audio 7.1 16, 4K2K60_444, Stereo Audio 2.0 17, 4K2K60_444, Dolby/DTS 5.1 18, 4K2K60_444, HD Audio 7.1 19, 4K2K60_444, Stereo Audio 2.0 HDR 20, 4K2K60_444, Dolby/DTS 5.1 HDR 21, 4K2K60_444, HD Audio 7.1 HDR 22, User define1 23, User define2 24~31, copy from hdmi output 1~8 32~39, copy from hdbt output 1~8	s edid in 1 from 1! s edid in 0 from 1!	input 1 EDID:1080p, Stereo Audio 2.0 all inputs EDID:1080p, Stereo Audio 2.0	1080p, Stereo Audio 2.0
r edid in x!	Get EDID status of the input x, x=0~8(0=all input)	r edid in 0!	input1 EDID: 4K2K60_444, Stereo Audio 2.0 input2 EDID: 4K2K60_444, Stereo Audio 2.0 input8 EDID: 4K2K60_444, Stereo Audio 2.0	

Command Code	Function Description	Example	Feedback	Default Setting
r edid data hdmi y!	Get the EDID data of the hdmi output y port, y=1~8	r edid data hdmi 1!	EDID: 00 FF FF FF FF FF FF 00	
r edid data hdbt y!	Get the EDID data of the hdbt output y port, y=1~8	r edid data hdbt 1!	EDID: 00 FF FF FF FF FF FF 00	
CEC Setting				
s cec in x on!	set input x power on by CEC, x=0~8(0=all input)	s cec in 1 on!	input 1 power on	
s cec in x off!	set input x power off by CEC, x=0~8(0=all input)	s cec in 1 off!	input 1 power off	
s cec in x menu!	set input x open menu by CEC, x=0~8(0=all input)	s cec in 1 menu!	input 1 open menu	
s cec in x play!	set input x play by CEC, x=0~8(0=all input)	s cec in 1 play!	input 1 play operation	
s cec in x pause!	set input x pause by CEC, x=0~8(0=all input)	s cec in 1 pause!	input 1 pause operation	
s cec in x stop!	set input x stop by CEC, x=0~8(0=all input)	s cec in 1 stop!	input 1 stop operation	
s cec in x rew!	set input x rewind by CEC, x=0~8(0=all input)	s cec in 1 rew!	input 1 rewind operation	
s cec in x mute!	set input x volume mute by CEC, x=0~8(0=all input)	s cec in 1 mute!	input 1 volume mute	
s cec in x vol-!	set input x volume down by CEC, x=0~8(0=all input)	s cec in 1 vol-!	input 1 volume down	
s cec in x vol+!	set input x volume up by CEC, x=0~8(0=all input)	s cec in 1 vol+!	input 1 volume up	
s cec in x ff!	set input x fast forward by CEC, x=0~8(0=all input)	s cec in 1 ff!	input 1 fast forward operation	
s cec in x previous!	set input x previous by CEC, x=0~8(0=all input)	s cec in 1 previous!	input 1 previous operation	
s cec in x next!	set input x next by CEC, x=0~8(0=all input)	s cec in 1 next!	input 1 next operation	
s cec hdmi out y on!	set hdmi output y power on by CEC, y=0~8(0=all hdmi output)	s cec hdmi out 1 on!	hdmi output 1 power on	
s cec hdbt out y on!	set hdbt output y power on by CEC, y=0~8(0=all hdbt output)	s cec hdbt out 1 on!	hdbt output 1 power on	
s cec hdmi out y off!	set hdmi output y power off by CEC, y=0~8(0=all hdmi output)	s cec hdmi out 1 off!	hdmi output 1 power off	
s cec hdbt out y off!	set hdbt output y power off by CEC, y=0~8(0=all hdbt output)	s cec hdbt out 1 off!	hdbt output 1 power off	
s cec hdmi out y mute!	set hdmi output y volume mute by CEC, y=0~8(0=all hdmi output)	s cec hdmi out 1 mute!	hdmi output 1 volume mute	
s cec hdbt out y mute!	set hdbt output y volume mute by CEC, y=0~8(0=all hdbt output)	s cec hdbt out 1 mute!	hdbt output 1 volume mute	
s cec hdmi out y vol-!	set hdmi output y volume down by CEC, y=0~8(0=all hdmi output)	s cec hdmi out 1 vol-!	hdmi output 1 volume down	
s cec hdbt out y vol-!	set hdbt output y volume down by CEC, y=0~8(0=all hdbt output)	s cec hdbt out 1 vol-!	hdbt output 1 volume down	
s cec hdmi out y vol+!	set hdmi output y volume up by CEC, y=0~8(0=all hdmi output)	s cec hdmi out 1 vol+!	hdmi output 1 volume up	
s cec hdbt out y vol+!	set hdbt output y volume up by CEC, y=0~8(0=all hdbt output)	s cec hdbt out 1 vol+!	hdbt output 1 volume up	
s cec hdmi out y active!	set hdmi output y active source by CEC, y=0~8(0=all hdmi output)	s cec hdmi out 1 active!	hdmi output 1 active source	
s cec hdbt out y active!	set hdbt output y active source by CEC, y=0~8(0=all hdbt output)	s cec hdbt out 1 active!	hdbt output 1 active source	

Command Code	Function Description	Example	Feedback	Default Setting
Network Setting				
r ipconfig!	Get the Current IP Configuration	r ipconfig!	IP Mode: Static IP: 192.168.1.72 Subnet Mask: 255.255.255.0 Gateway: 192.168.1.1 TCP/IP port=8000 Telnet port=10 Mac address: 00:1C:91:03:80:01	
r mac addr!	Get network MAC address	r mac addr!	Mac address: 00:1C:91:03:80:01	
s ip mode z!	Set network IP mode to static IP or DHCP, z=0~1 (z=0 Static, z=1 DHCP)	s ip mode 0!	Set IP mode:Static (Please use "s net reboot!" command or repower device to apply new config!)	
r ip mode!	Get network IP mode	r ip mode!	IP Mode: Static	
s ip addr xxx.xxx.xxx.xxx!	Set network IP address	s ip addr 192.168.1.100!	Set IP address: 192.168.1.100 (Please use "s net reboot!" command or repower device to apply new config!) DHCP on, Device can't config static address, set DHCP off first.	
r ip addr!	Get network IP address	r ip addr!	IP:192.168.1.100	
s subnet xxx.xxx.xxx.xxx!	Set network subnet mask	s subnet 255.255.255.0!	Set subnet Mask address:255.255.255.0 (Please use "s net reboot!" command or repower device to apply new config!) DHCP on, Device can't config subnet mask, set DHCP off first.	
r subnet!	Get network subnet mask	r subnet!	Subnet Mask: 255.255.255.0	
s gateway xxx.xxx.xxx.xxx!	Set network gateway	s gateway 192.168.1.1!	Set gateway: 192.168.1.1 Please use "s net reboot!" command or repower device to apply new config! DHCP on, Device can't config gateway, set DHCP off first.	
r gateway!	Get network gateway	r gateway!	Gateway:192.168.1.1	
s tcp/ip port x!	Set network TCP/IP port (x=1~65535)	s tcp/ip port 8000!	Set TCP/IP port:8000	
r tcp/ip port!	Get network TCP/IP port	r tcp/ip port!	TCP/IP port:8000	
s telnet port x!	Set network telnet port (x=1~65535)	s telnet port 23!	Set Telnet port:23	
r telnet port!	Get network telnet port	r telnet port!	Telnet port:23	

Command Code	Function Description	Example	Feedback	Default Setting
s net reboot!	Reboot network modules	s net reboot!	Network reboot... IP Mode: Static IP: 192.168.1.72 Subnet Mask: 255.255.255.0 Gateway: 192.168.1.1 TCP/IP port=8000 Telnet port=10 Mac address: 00:1C:91:03:80:01	
s uart x datalen y!	Set the data length of x hdbt uart, x=0-8, y=1-2, 1:8bit 2:7bit	s uart 1 datalen 1!	hdbt uart1 data len is 8bit	
s uart x baudrate y!	Set the baudrate of x hdbt uart , x=0-8, y=1-8, 1: 115200(Default) 2: 57600 3: 56000 4:38400 5:19200 6:14400 7:9600 8:4800	s uart 1 baudrate 1!	hdbt uart1 baudrate is 115200	
s uart x parity y!	Set the Parity of x hdbt uart, x=0-8, y=1-3, 1:none 2:odd 3:even	s uart x parity 1!	hdbt uart1 parity is none	
s uart x type z senddata y end!	Send data y from x hdbt uart, z=0 ascii, z=1 hex ,x=0-8	s uart 1 type 0 senddata abcdefg end!	hdbt uart1 data: abcdefg	
r uart status x!	Get the Status of x hdbt uart , x=0-8	r uart status 1!	hdbt uart1 baudrate 9600, datalen 8bit, parity none	

12. Application Example

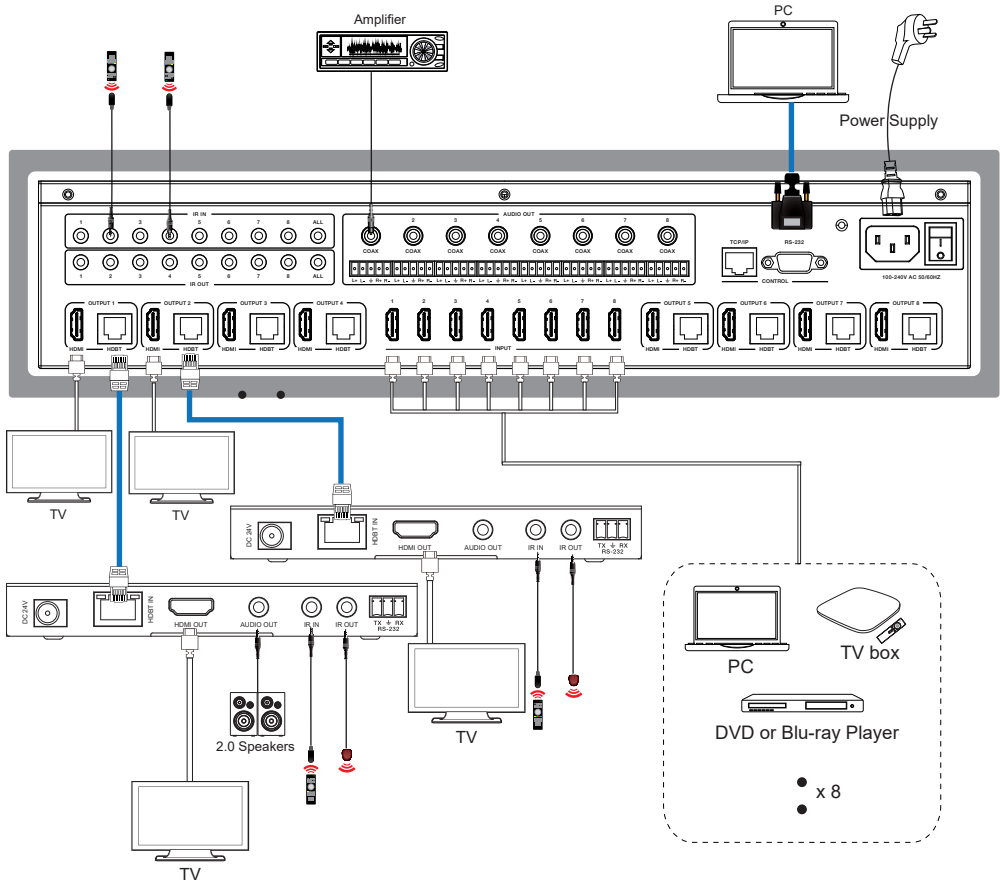

The terms HDMI and HDMI High-Definition Multimedia interface, and the HDMI Logo are trademarks or registered trademarks of HDMI Licensing LLC in the United States and other countries.